



**RADIATION MONITOR**

**RADEX RD1706**

**OPERATING MANUAL**

RADEX and РАДЭК are the registered brands of QUARTA-RAD Ltd.

Radiation monitor RADEX RD1706, hereinafter referred to as the device, is designed for detection and evaluation of the level of ionizing radiation hereinafter referred to as irradiation. The device evaluates radiation environment by the magnitude of the ambient equivalent of dose rate  $H^*(10)$  of gamma radiation (hereinafter referred as a dose rate) with taking into account gamma radiation and the pollution of objects by sources of beta particles.

The device obtains the following distinctive features:

- \* period of observation shortens with the increase of a dose rate;
- \* increase in the number of observation cycles improves the reliability of indications;
- \* smooth threshold signal changing in a wide range;
- \* displaying the value of a background dose rate;
- \* displaying a dose rate exceeding over a background dose rate;
- \* vibra-call signal as the additional alarming function;
- \* possibility to function with one battery of «AAA» type.

The monitor is used for evaluation of the radiation level afield, indoors and for estimation of a contamination level of materials and products.

Operating conditions: at the temperature ranging from  $-20\text{ }^{\circ}\text{C}$  to  $+50\text{ }^{\circ}\text{C}$  with a relative humidity no more than 80 % at the temperature of  $+25\text{ }^{\circ}\text{C}$ .

The results obtained with this device can not be used for official decision on radiation environment and degree of pollution.

## TABLE OF CONTENTS

Precaution measures.....	5
Physical configuration.....	7
Display format in monitoring and background modes.....	9
Operating mode.....	12
Monitoring mode.....	13
Menu mode.....	14
LEVELS.....	15
BACKGROUND.....	18
SETUP.....	22
SERVICE.....	24
Background mode.....	25
Preparations for using.....	26
Device using.....	27
Radiation control in quarters and public buildings.....	29
Marking and sealing.....	30
Packing.....	30
Transportation and storage.....	30
Technical service.....	31
Maintenance and updating.....	31
Troubleshooting.....	31
Performance data.....	32
Technical specifications.....	33

## **Precautionary measures**

Do not use, place or storage the device for a long time under the impact of intense direct solar light or height temperature, for example on an instrument board or in a trunk. The impact of the sunlight or temperature can lead to electrolyte leakage from power elements, their overheating or explosion and therefore to arson, burn and other injuries. High temperature can also cause malformation of the device's frame.

Do not storage the device in damp and dusty places. It can cause arson, electrical shock and other damages.

Protect the unit from shocks and heavy mechanical stress that can cause damages of the device.

This device is a high-precision technology. Avoid its falling and mechanical stress.

The device is not water-proof; it cannot be used in the environment with a high humidity or in water. If the product wets, immediately switch off the device and apply to «QUARTA-RAD» Ltd. If a small amount of water has reached its surface or it was exposed to salty air it is necessary to switch off a product, to wipe it with dry fabric, to place it in a warm dry premise and to dry it before a complete evaporation of moisture from its internal.

Keep the device away from devices such as electric or magnetic motors which generate strong magnetic fields. Do not use and place the monitor close to areas where high electromagnetic signals are generated, such as transmitting towers. Superhigh frequencies can lead to malfunctioning.

Do not attempt yourself to dismantle or fix the device.

Do not place the unit in a microwave and do not carry out any monitoring with ionizers and ozonizers turned on.

Do not let particles penetrate through a perforated hole inside the unit.

Do not touch electrical links of a battery block. It can cause corrosion of links and affect normal functioning. Condensate can occur on internal parts of the device in case of a rapid temperature decrease from higher to lower level. To prevent this place the device inside a plastic bag. Keep it there till its temperature becomes of the environment.

In order to prevent damages to the unit do not use it if a condensate has appeared. If it is so extract power batteries from the unit and wait for a while till a condensate evaporates. It is possible to use the device after a complete vaporization of a condensate only.

Extract power batteries if the device is not being used for a long time and keep the unit in dry and cool conditions.

It is not recommended to keep the unit in places like labs where chemical agents potentially may cause corrosion.

It is necessary to check working capacity of the unit before usage if it was kept in storage for a long time.

### **Precautionary measures for LCD**

- \* LCD possesses a high-precision technology. Nevertheless a disabled pixel can appear on LCD in the form of a permanent black dot on it, and it is not considered as a malfunction and does not impact on the image.
- \* Do not hit and press on the LCD as it can cause fractures and damages of the display.
- \* In case of LCD surface contamination, switch off the device and wipe it gently with a soft tissue that does not scratch it.
- \* Do not leave the device under the impact of a direct solar and fluorescent light for a long time.
- \* Do not let deleterious chemical substances, such as acids, alkali, and solvents etc. fall on the display and do not keep it in places where these substances are located.
- \* Response time of the LCD increases at low temperatures and display can darken at high temperatures. Standard features of display will restore at room temperature.

### **Precautionary measures for power elements**

- \* Keep power elements out of reach of children. Its chemical agents represent danger in case of casual swallowing. In this case apply to a doctor immediately.
- \* Do not hold a power supply with metallic tools such as pliers for it can cause a short circuit.
- \* Do not heat or dismantle power elements for it can fracture.

## Physical configuration

The unit is designed as a portable and handheld device with a self-contained power supply.

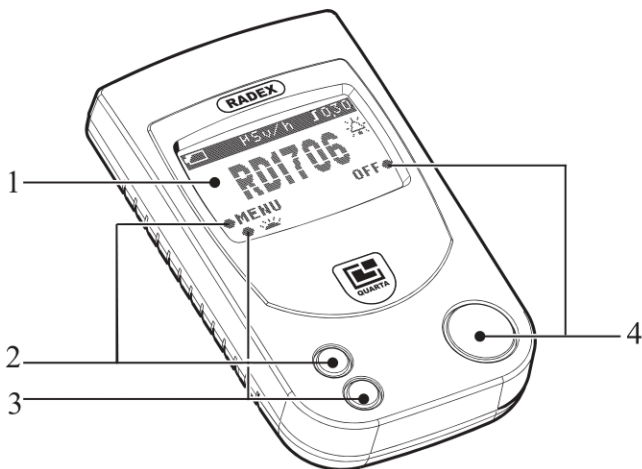

1. LCD

2. «**MENU**» button and its function icon (on display).

The button responds to five functions:

- «**MENU**» – responds in «Monitoring» and «Background» modes;
- «**SELECT**» – responds in «Menu» mode;
- «**CHANGE**» – responds in «Menu» mode;
- «**START**» – responds in «Menu» mode;
- «**◀◀**» – shifting the cursor of an altering figure in «Menu» mode.

3. «**CURSOR**» button and its function icon (on display).

The button responds to two functions:

- «**☀**» – switches on LCD backlight in «Monitoring» and «Background» modes;
- «**▼**» – moves cursor and alters numbers in «Menu» mode.

#### 4.«OFF» button and its function icon.

The button has six functions:

- switches on the device;
- «RETURN» – sends you one level back in «Menu» mode;
- «EXIT» - transfers you from «Menu» to «Monitoring» or «Background» modes;
- «END» – responds in «Menu» mode;
- «SAVE» - responds in «Menu» mode;
- «OFF» - switches off the device in «Monitoring» and «Background» modes.

The icons suggest to use the functions of buttons making it easier to operate. Further in the text only icons of buttons will be pointed out. Instruction to press the button with a corresponding icon means clicking the applicable button of the device.

The pressed button of the unit has animation, meaning that clicking any active button leads to temporary altering the shape of an icon on display from «●» to «○» and back to «●». In all displays shown below the animation of pressed buttons is not depicted.

The cover for a battery bay is disposed on the backside of the unit.

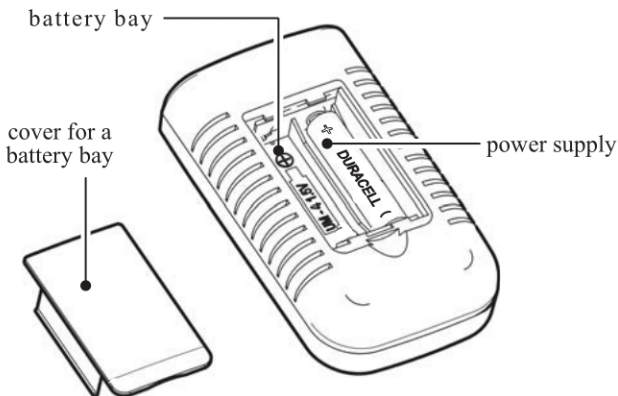





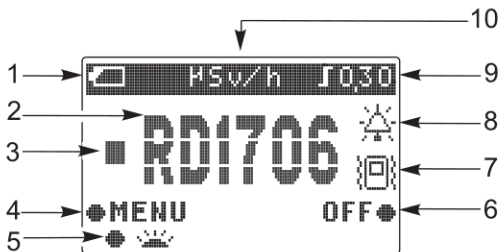

## Display format in «Monitoring» and «Background» modes

After activating the unit displays a screen of RD1706 with button icons and individual or manufacture settings.

Location of 14 fields and possible icons are shown on two display pictures below.



1. Icon of battery charge:

- <<  >> - complete battery charge;
- <<  >>- partly discharged battery;
- <<  >>- completely discharged battery

2. Conventional symbol of the unit.

3.

- <<  >>- icon of quantum registration.

4. Icon of «MENU» button. This field contains one of the icons displaying the current «MENU» button function:

<<MENU >>



<<SELECT >>

<<CHANGE >>

<<START >> or

<<  >>

5. Icon of «**CURSOR**» button (page 7). This field contains one of the following icons:

- «  » - switching on backlight in «Monitoring» and «Background» modes;
- «  » - moving cursor and altering value of a threshold in «Menu» mode.

6. Icon of «**OFF**» button (page 7). This field contains one of the following icons:

- « RETURN » - responds in «Menu» mode,
- « EXIT » - while transferring from «Menu» to «Monitoring» and «Background» modes,
- « END » - responds in «Menu» mode,
- « SAVE » - responds in «Menu» mode,
- « OFF » - responds in «Monitoring» mode.



7. Vibra-call icon:

- «  » - vibra-call is on. When the vibra-call is off the icon is lacking;

8. Bell icon:

- «  » - the audio signal is on. When the bell is off the icon is lacking;

9. Threshold signal icon, for example

- «  » - signaling starts when indications reach 0,30  $\mu\text{Sv/h}$  (threshold signal can be set in a range from 0.10 to 0.90  $\mu\text{Sv/h}$ ) or
- «  » - when threshold signal is off.

10. Units icon:

- «  » - microSievert per hour.

After a short cycle of observation the screen with read outs appears.

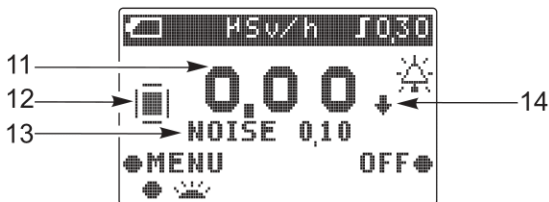



11. Digital readings of a dose rate in  $\mu\text{Sv/h}$ ;

12. Icon of the number observations performed:

«  » - corresponds to the short (half of the complete) cycle of observation

«  » - corresponds to one complete cycle of observation;

«  » - corresponds to two complete cycles of observation;

«  » - corresponds to three complete cycles of observation;

«  » - corresponds to four and more complete cycles of observation.

13. The value of a dose rate - «NOISE XXX», where XXX is the value of a dose rate in  $\mu\text{Sv/h}$ ;

14. «  » - Icon showing that the value of a dose rate is less than the value of a background dose rate. At the same time «0,00» value displays on the screen.

«  » - Icon showing that the value of a dose rate is over  $999\mu\text{Sv/h}$ . At the same time «999» value displays on the screen.

## Operating mode

There are three operating modes in the unit: «Monitoring», «Background» and «Menu».

The «Monitoring» mode is set automatically at start of unit's functioning. This mode gives estimation of a dose rate and indications output to the LCD. The time of a dose rate estimation varies from 24 sec when a dose rate is less than  $3,5 \mu\text{Sv/h}$  till 1 sec when a dose rate exceeds  $72,0 \mu\text{Sv/h}$ .

The button «**CURSOR**» in «Monitoring» mode (page 7) fulfills the function of turning on/off backlight of the display. A short term click turns on backlight for two seconds. It allows seeing indications in a twilight or darkness. The importance of a backlight during a bright illumination is not remarkable.



Note. It is important to remember that a frequent switching of backlight shortens strongly the time of continuous operation of the device.

«Background» mode (page 25) switches on in «BACKGROUND» section (page 18) in «Menu» mode. Just as in «Monitoring» mode the dose rate estimation is performed but it gives out two indications simultaneously; they are the exceeding of a dose rate over background dose rate and additionally a value of a dose rate of background. This mode is convenient for examining premises, when it is important to know the difference between indications indoors and those on an open air and how to determine correctly the value of a dose rate outdoors.

The button «**CURSOR**» (page 7) turns on backlight in «Background» mode.

«Menu» mode turns on by clicking «**MENU**» button (page 7) in case if altering of manufacture's set up is needed. In «Menu» mode the estimation of a dose rate is not being conducted.

## Monitoring mode



This mode gives the value of a dose rate displaying indications on the LCD. Every registered quantum is displayed on LCD as «  » icon. Blinking frequency of «  » icon is proportional to the strength of a radiation dose rate.

A short cycle of observation is introduced in order to reduce a waiting time of the first reading. The indications of a short cycle and its icon «  » (page 11, screen 12) are displayed twice faster than in a complete cycle, but the readings of a short cycle are approximate and must be precised during the next complete cycle. Readings received in this cycle are useful for the initial dose rate estimation.



After a complete cycle of observation the readings and icon «  » are displayed.



The icon showing the number of observations performed allow determining visually the number of averaging cycles. It is useful for detecting a place of a strong variation in a dose rate (local radioactive contamination) for in this case the icon «  » changes to «  » and it is easy to remark. At the same time the estimation of a dose rate starts all over again from the first cycle, so averaging indication of the previous cycles are not taking into account.

The period of observation depends on a dose rate value and varies from 26 sec to 1 sec. The period of observation equals to 26 sec when a dose rate value is in the range from 0,05  $\mu\text{Sv/h}$  to 3,5  $\mu\text{Sv/h}$  and when a dose rate value exceeds 3,5  $\mu\text{Sv/h}$  the time of observation gradually shortens and reaches its minimum of 1 sec at a dose rate of 72,0  $\mu\text{Sv/h}$ . Further a dose rate increase does not shorten the time of observation (it remains 1 sec).

## Menu mode



In «Menu» mode you can arrange the magnitude of a threshold signal, turn on/off alarm and vibra-call, enable «Background» mode, estimate the background radiation and also receive reference information.

Switching to «Menu» mode ceases monitoring of a dose rate. In order to switch from «Monitoring» to «Menu» mode press and release «MENU» button (page 7). The main menu displays on the screen.



At start the icon «▶» is always situated on the upper line of the menu, like in this case it is opposite to «LEVELS» section.

Note. On the screen a pointer «» demonstrates which button it is necessary to click in order to switch from the present screen to the following one.

«CURSOR» button shown on the screen as «» moves the pointer in «Menu» section. Clicking the button «» moves the cursor down only. After reaching the lowest position it transfers to the upper line.

Choosing the section needed of the menu is implemented by pressing «SELECT» button.

Returning to the previous section is implemented by pressing «RETURN» button.

Switching from «Menu» to «Monitoring» modes is implemented by pressing «EXIT» button. This switching to «Monitoring» mode causes the estimation of irradiation to start from the first cycle.

All individual settings are saved after turning off the device as well.

## «LEVELS» section

Exceeding of a threshold dose rate value which can be set in «LEVELS» section provokes to alarm signal actuation.

A threshold signal should be switched on when it is necessary to receive alarm or vibra signals in case of a fixed radiation dose rate exceeding. User himself sets a value of a threshold signal (range from 0,1 up to 99,0  $\mu\text{Sv/h}$ ). Choosing the type of a signal (audio or vibra signal) is made in «SETUP» section (page 22). Thus, if a dose rate is registered during one observation exceeds the installed threshold level than turns on one of the two or both signals:

- a) when AUDIO signal is activated than with every quantum captured the sound signal will occur. If the selected threshold exceeds 3,0  $\mu\text{Sv/h}$  than a single sound signal is heard;
- b) when vibra signal is on it will function till the end of the cycle of observation.

When a threshold signal is off, audio signal actuates with every registered quantum and a vibra-call does not function at all.

Example of changing a level of a threshold signal from 0,30  $\mu\text{Sv/h}$  to 4,50  $\mu\text{Sv/h}$  is presented below.

To change the level of a threshold switch from «Monitoring» to «Menu» mode (screen 1). The main menu displays on the screen (screen 2).

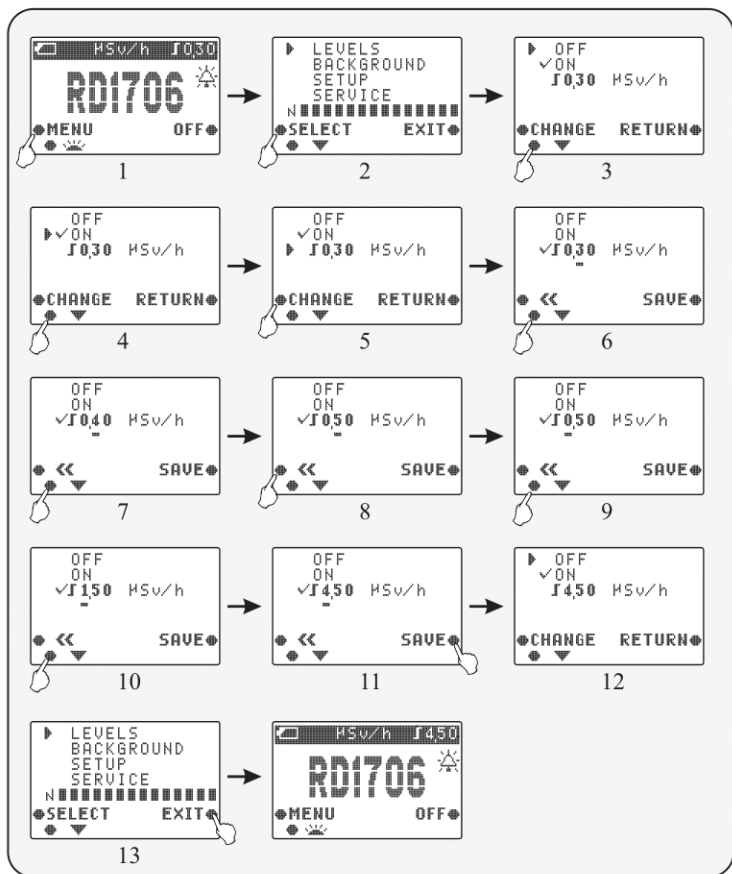



Press «**SELECT**» button and the screen 3 will appear. A double-click on «**▼**» button (screens 4 and 5) moves the cursor «**▶**» to «0,30  $\mu\text{Sv/h}$ ».

Press «**CHANGE**» button and the icon «**✓**» will be placed opposite to «0,30  $\mu\text{Sv/h}$ » and a digit 3 becomes underlined (screen 6);

A double-click on «**▼**» button establishes «0,30  $\mu\text{Sv/h}$ » value (screens 7 and 8).

Press «**◀**» button and the underlined figure moves one position left (screen 9).

Press four times «**▼**» button and the required value of «4,50  $\mu\text{Sv/h}$ » will be set (screens 10 and 11).

Press «**SAVE**» button and «**✓**» icon places opposite to «ON», «**▶**» icon stands opposite to «OFF» (screen 12)

To return to the main menu screen press «**RETURN**» button (screen 13).

To return to «Monitoring» mode press «**EXIT**» button. The screen «RD15706» appears and the icon of the new selected threshold («**4.50**») will be in the right upper corner. «Monitoring» mode starts functioning at the same time.

The installed threshold signal is not activated if «**✓**» icon stands opposite to «OFF» and the device operates according to settings which are in «**SETUP**» section (page 22). For example, the audio beep signals with every registered quantum if the icon «**✓**» is placed only opposite to «**AUDIO**». If the icon «**✓**» is placed only opposite to «**VIBRA-CALL**», a vibra signal will not actuate because a vibra-call responds with a turned on threshold level only.

## «BACKGROUND» section

«Background» mode can be turned on in this section. It calculates an average value of a background dose rate.

To activate «Background» mode switch from «Monitoring» mode to «Menu» mode (screen 1). A main menu displays (screen 2).

Press «▼» button and cursor «█» places opposite to «BACKGROUND» section (screen 3).

Press «SELECT» button and screen 4 appears.

Double-click on «▼» button and cursor «█» places opposite to «BACKGROUND» (screens 5 and 6).

Press «CHANGE» button. Screen 7 appears where digits «1», «2», «3», «4», «5» determine a number of sighting points, which are necessary for conducting evaluation of a background radiation.

Select the first sighting point according to recommendations described on page 29.

Press «START» button, screen 8 appears on display and a cycle of estimation of a background starts. Approximately within 100 sec «» icon appears on the display and the cycle of background estimation in the first sighting point ends (screen 9). Screen 10 with indications in the first line which stand for the value of background dose rate in the first sighting point appears on the display.

Note. A cycle of estimation of a background can be interrupted. To do so press «RETURN» button, thus a cycle of estimation will be interrupted and screen 4 revealed.

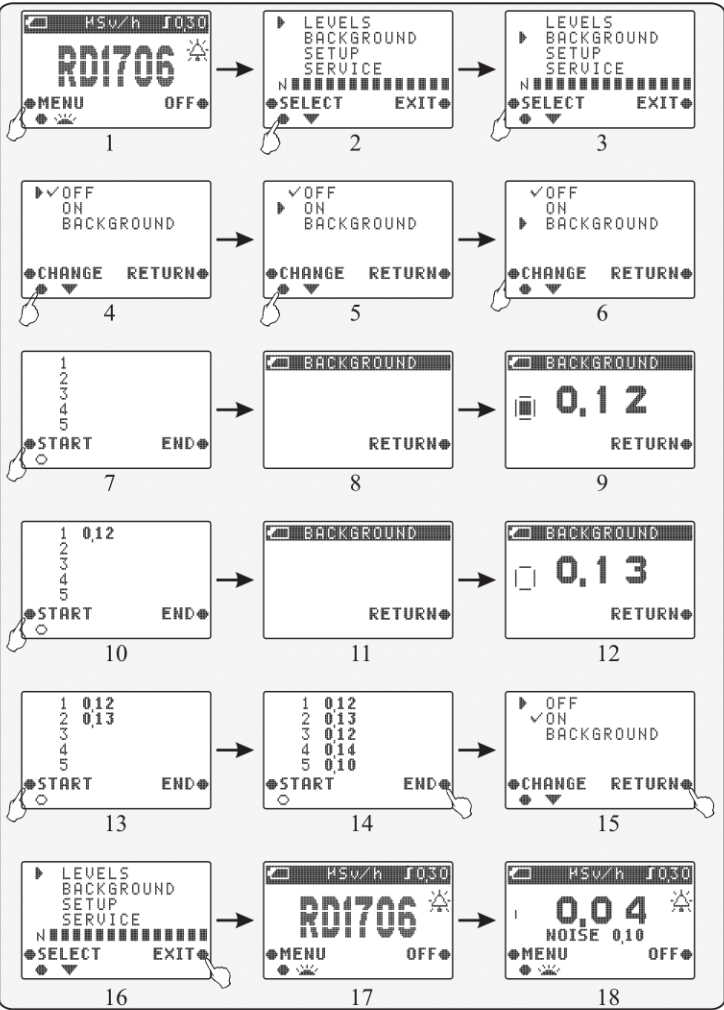

Press «**START**» button and wait till completion of the cycle of «**BACKGROUND**» estimation (screen 13). A value in the second line is the evaluation of a dose rate in the second sighting point (screen 14). In order to receive accurate estimation of a background it is necessary to conduct similar observations in 5 sighting points (screen 15).

Note. A number of sighting points can be reduced by clicking «**END**» button without waiting for ending of the fifth cycle of estimation. But it reduces integrity of the reading.

After 5 indications have been made press «**END**» button and screen 15 appears.

To return to the main screen in «**Menu**» mode press «**RETURN**» button and screen 16 appears.

Press «**EXIT**» button, the screen «**RD1706**» (screen 17) appears and «**Background**» mode starts operating (page 25).

After a short cycle of observation two indications will be displayed (screen 18):

- a) a dose rate difference between the average indication and background;
- b) background dose rate, selected from indications of 5 sighting points.

In order to terminate «**Background**» mode and to return to «**Monitoring**» mode it is necessary to switch to «**Menu**» mode (screens 1 and 2) and to select «**BACKGROUND**» section (screen 3) where «**✓**» icon should be placed opposite to «**OFF**» (screen 5).

To return to the main menu screen of «**Menu**» mode press «**RETURN**» button, screen 6 appears.

Press «**EXIT**» button. Screen «**RD1706**» reveals (screen 7) and «**Monitoring**» mode starts functioning. After short cycle of observation only one read out of a dose rate displays.

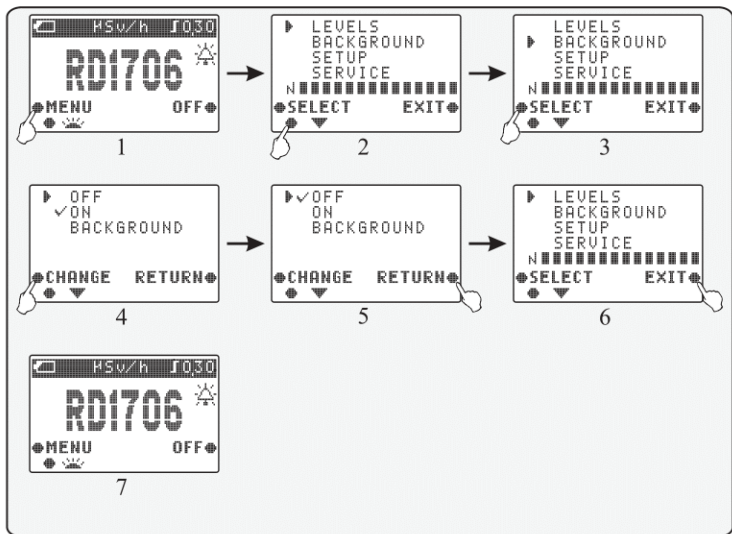

## «SETUP» section

Two types of signal can be chosen in «SETUP» section: «AUDIO» and «VIBRA-CALL» which can be turned on/off by placing « ✓ » icon opposite to a correspondent choice.

Example of activating a vibra signal instead of an audio one is demonstrated below.

To activate a vibra signal switch from «Monitoring» to «Menu» mode by pressing «MENU» button (screen 1).

Press « ▼ » button two times, the cursor « ► » will be displaced opposite to «SETUP» section (screen 2).



Press «SELECT» button, screen 3 appears.

Press «CHANGE» button, « ✓ » icon opposite to «AUDIO» disappears (screen 4).

Press « ▼ » button, the cursor « ► » is displaced opposite to «VIBRA-CALL» (screen 5).

Press «CHANGE» button, « ✓ » icon opposite to «VIBRA-CALL» appears, meaning activation of a vibra signal (screen 6).

To return to the main menu screen press «RETURN» button, screen 6 will appear.

To start «Monitoring» mode press «EXIT» button, «  » icon is presenting while «  » icon is lacking on the main screen «RD1706».

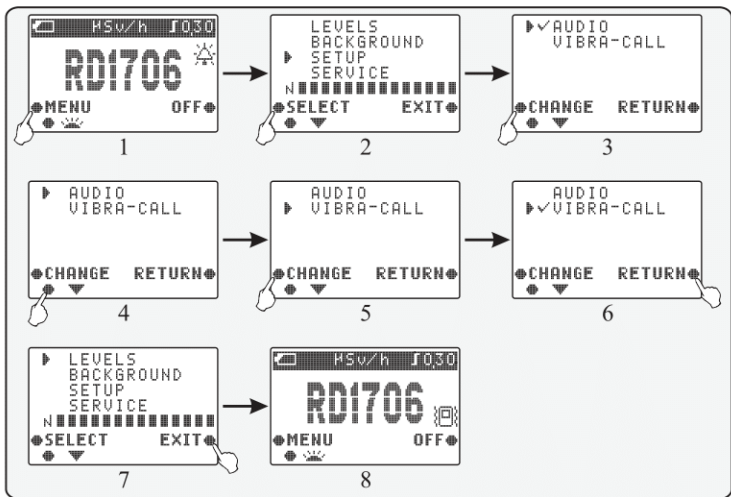

From this moment a vibra signal turns on if the value of a dose rate exceeds the installed threshold of alert when a threshold function is not turned off (page 15). A vibra signal starts functioning in a pulse-mode till the end of an observation cycle.

Note. Using a vibra call shortens sharply the device's non stop operating time.

Setting an audio signal is similar to modifying a vibra call.

In «Monitoring» and «Background» modes the installed setting are revealed with icons on the main screen «RD1706»:

«  » - audio signal is on,

«  » - vibra call is on.

When audio and/or vibra signals are off the icons are lacking.

Note. 1.A sound signal is usually used in noisy premises or on the street.

2.In quiet places such as offices and apartments it is recommended to use vibra call or sound alarm with a threshold installed.

## «SERVICE» section

In «SERVICE» section the following is mentioned:

- \* phone number of an organization where a radiation monitor RADEX RD1706 can be acquired,
- \* phone number of the QUARTA-RAD Ltd. Company, which sells wholesale a radiation monitor RADEX RD1706;
- \* internet address [www.quarta-rad.ru](http://www.quarta-rad.ru), where you can find news about a radioactive situation in Russia, get acquainted with radioactivity safety norms and other normative documents.

Place a pointer « ► » opposite to «SERVICE» with «CURSOR» button. Press «SELECT» button.

To return to the main menu press «RETURN». Pressing «EXIT» transfers to «Monitoring» mode.



## «Background» mode

This mode is convenient for examining inside the buildings.

In «Background» mode the estimation of the radiation dose rate is similar to the one in «Monitoring» mode (page 13), yet the display gives not just one but two indications. One stands for exceeding of a dose rate over background dose rate, the second is for a background dose rate. This mode is convenient for examining inside buildings, when it is necessary to know how indications indoors differ from the ones outdoors.

The actuation of the «Background» mode and evaluating background dose rate are given in «BACKGROUND» section (page 18). In «Background» mode screen RD1706 has the same view as in «Monitoring» mode but after the end of estimation cycle two values are displayed:

1.- exceeding of a dose rate over background dose rate (in the example it is  $0,07 \mu\text{Sv/h}$ )

2.- value of a background dose rate (in the example it is  $0,10 \mu\text{Sv/h}$ )



That a dose rate value in this example equals to  $0,07 + 0,10 = 0,17 \mu\text{Sv/h}$ .



When the value of the radiation dose rate is less than of a background, the value «0,00» and the icon «» are displayed.

Switching the device from «Background» to «Monitoring» mode is done in «BACKGROUND» section (page 18) by placing «» icon opposite to «OFF».

The rules and sequence of defining the average value of background dose rate are covered on page 29.

## Preparations for using

Before actuating the device read the operation manual and functions of operating controls carefully (page 7).

Installation of power elements

1. Take off the cover of a battery compartment.
2. Install into the battery compartment one or two power elements size "AAA" abiding polarity of contacts.
3. Install the cover of a battery compartment.

When conducting a long-term examination we recommend you to install two power elements, for a short-term just one as it is possible to use one power element.

Do not mix the used and new power elements.

We recommend altering individual settings before conducting the evaluation (page 22).

Recommendations on examining the objects

Remember that the ionizing radiation has a static random character therefore indications of the monitor in identical conditions will not remain strict. For a precise definition of a dose rate it is necessary to conduct not less than 4 cycles of monitoring without turning off the device.

For defining radioactivity of the food, household items etc. approximate the monitor to the object of examination on a distance from 5 to 10 mm and turn it on.

For defining radioactivity of fluids, the evaluation of a dose rate is conducted above the unclosed surface of a fluid. For the device protection it is recommended to use a polyethylene package, but no more than in one layer. Do not let the moisture to get inside the device.

The estimation output exceeding the natural background that is ordinary for the given location is the evidence of the radioactive impurity of the inspected object. The "Background" mode is presented for convenience of defining such objects (page 25).

Detecting the location of an ionizing radiation source it is necessary to move a working device above the surface of examined object, being oriented on frequency increase of a sound signal (in menu settings: levels - off, audio - on). Remember, that the frequency of signals as approaching the source will increase sharply, and in accordance with moving away will decrease in the same manner.

## Device using

Switching on the device

To switch on the device press «OFF» button (page 7) and the screen «RD1706» will be displayed.







The sequence of survey

After switching on the device the examination of the radioactive environment starts. During the time of observations every registered quantum of radiation is accompanied by a displayed presentation « ■ » icon (page 9) and a short audible signal, if the sound is switched on and the threshold is off. The frequency of occurrence of the icon on display is proportional to a dose rate. After 13 seconds of unit's functioning, the first result of a short cycle\* and its icon « | ■ » are displayed.



\* The short cycle of observation is equal to a half of a complete cycle and made for prompting the deriving of preliminary results. The first reliable result depends on a dose rate and is displayed after 1-26 seconds of observation and designated by « | ■ » icon.



- Icons «  »- corresponds to one complete cycle of observation;
- «  »- corresponds to two complete cycles of observation;
- «  »- corresponds to three complete cycles of observation;
- «  »- corresponds to four and more complete cycles of observation.

The first results of observation is displayed as an average value of two short cycles, the second - as average value of the two complete cycles of observation, the third - as average value of three complete cycles of observation and each following result - as average value of four previous observations.

The device analyzes a diversion of the current value regarding the result of a previous observation and averages it. If the difference exceeds a defined value, the current result is displayed instead of the average one.

For example, results of three observations the average result is  $0,20\mu\text{Sv/h}$  and the value  $0,80\mu\text{Sv/h}$  is registered in the fourth cycle, than the result of the fourth observation will not be averaged and we shall see  $0,80\mu\text{Sv/h}$  and «  » icon. This function of the article allows detecting sharp changes of a dose rate.

If you want to find a source of radiation turn off a threshold signal, switch on audio signal and pay attention not to digital readouts only but to a sound frequency and frequency of appearances of «  » icon. Its appearance frequency is proportional to a dose rate thus the higher the frequency the closer you are to a source.

### Switching off the device

To switch off the device press "**OFF**" button (page 7) and hold it till disappearance of the messages from the display.

## **Radiation control in quarters and public buildings.**

According to modern ideas about danger of small doses of radiation, the defensive measures of ngabited buildings should be conducted if a dose rate of gamma radiation inside a building exceeds a dose rate outside for more than  $0,20\mu\text{Sv/h}$ .

The estimation of a dose rate outside (background) is carried out near to the inspected building not less than in 5 sighting points standing from 30 to 100 m apart from buildings and facilities and not closer than 20 m from each other. The sighting points of estimation should be selected on location with a natural soil without any man-caused modifications (road metal, sand, asphalt) and radioactive contamination. The unit should be at 1 m high above the earth surface.

The total time of estimation of a background dose rate will take 20 - 30 minutes but if you want to receive authentic results it is necessary to conduct a complete term examination.

For your convenience «Background» mode (page 25) is supplemented to the device which makes it easier to conduct examination.

## Marking and Sealing

On the frame of the device are marked:

- trade mark of the manufacturer;
- trade mark - RADEX.

Conventional designation of the monitor - RD1706 appears on display at its turning on.

The assembly number of the device is on the main menu screen.

The device is not sealed up by the manufacturer.

## Packing

Packing ensures the safety of the device during the transportation.

The packing of device must be carried out in closed aerated premises at the temperature from +15 to +40°C and humidity up to 80 %, and without aggressive admixtures and dash in environment.

## Transportation and storage

The device in the manufacturer's packaging may be transported by any transport at any distance.

Arrangement and restraint of the container with the packed product in vehicles should provide a steady condition the container and exclude it's moving during transportation.

At transportation of the device it is necessary to ensure its protection from the atmospheric precipitates.

The conditions of transportation of the device in the package must correspond to:

- temperature span ..... from -20 to +40 °C
- relative humidity at +25 °C, not higher than.....80%

Before putting the device into operation it should be kept in the warehouse in a package of the manufacturer at temperature of from +5 to +40 °C and RH up to 80 % at temperature of +25 °C.

It is not allowed to keep the device without packing.

The device at temperature below 0 °C should be kept for an hour in the premise at a room temperature before opening and putting into operation.

## Technical service

The maintenance of the unit involves:

- 1) dusting off the unit from an outboard surface;
- 2) power elements should be replaced if the message «  » displays;
- 3) power elements should be expelled from battery compartment in case of a long term of interruption (more than one month);
- 4) wipe the display only with a soft tissue. During cleaning the device should be off.

Do not let smaller articles penetrate the device through a perforation.

## Maintenance and updating

The unit is no longer subject to maintenance or updating.

## Troubleshooting

Possible malfunction	Possible cause of malfunction	Way of clearance
There is no information on display after turning on.	The power elements are not installed or the power elements are installed disregarding the polarity.	Install the power elements in accordance with the polarity
The message «  » is displayed.	The power elements are discharged below the possible level.	Replace the power elements.

## **Actions in extreme conditions**

### **CAUTION!**

IF THE ITEM HAS DISPLAYED A DOSE RATE MORE THAN  $1.20 \mu\text{Sv/h}$  IT IS NECESSARY TO LEAVE THIS ZONE URGENTLY AND APPLY TO A STATE SANITARY - EPIDEMIOLOGICAL OFFICE FOR CONDUCTING A DETAILED RADIATIVE EXAMINATION.

## **Performance data**

The radioactivity monitor RADEX RD1706, evaluates radiation environment by the magnitude of the ambient equivalent of dose rate  $H^*(10)$  of gamma radiation with taking into account gamma radiation and the pollution of objects by sources of beta particles.

### **Individual settings:**

- switches on/off alarm signal;
- switches on/off vibra-call signal;
- choosing a threshold level which exceeding turns on alarm and vibra-call signals;
- evaluation of a background dose rate;
- displaying a value of a background dose rate;
- displaying a dose rate exceeding over a background dose rate;
- possibility to function with one battery of «AAA» type although it reduces the time of a non-stop performance.



## Technical specifications

Range of dose rate indications, $\mu\text{Sv/h}$ .....	0,05 to 999
Range of registered energy:	
1) gamma radiation, MeV .....	0,1 to 1,25
2) X-ray radiation, MeV .....	0,03 to 3,0
3) beta radiation, MeV .....	from 0,25 to 3,5
Reproducibility of indications (at confidential probability 0.95),%.....	7+6/P
P is a doze rate in $\mu\text{Sv/h}$ .	
Threshold levels, $\mu\text{Sv/h}$ .....	0,1 to 99,0
Time of calculation, s.....	1 to 26
Time of indication.....	continuously
Power elements, size «AAA».....	one or two
Time of continuous work of the device, not less than, hours...500	
Overall dimensions, height x breadth x depth, mm, not more than.....	105x60x26
Weight (without power elements), kg, not more than.....	0,09

### Notes:

- 1 Period of observation shortens with the increase of a dose rate. The time of observation shortens with the value higher than  $3,0 \mu\text{Sv/h}$ .
- 2 The increase in the number of performed cycles improves the reliability of indications.
- 3 The continuous operating of the device is calculated on the basis of manufactures settings and two batteries with a capacity of 1350 mAh. These elements have 24 AU abbreviation and others.
- 4 Manufactures settings: threshold-..... « $0,30 \mu\text{Sv/h}$ »,  
background mode -..... OFF,  
settings: alarm signal-..... ON,  
vibra-call signal -.....OFF.

# Memo

.....

.....

.....

.....

.....

.....

.....

.....



